





P.O. Box 720700 Pinon Hills, CA. 92372  
 phone 760-868-6962 fax 760-868-2131

**Authorized Distributor:**

We Understand Your Time is Money...  
 We Understand You Want to Do it Right the First Time...  
 The Quality of our Products not only  
 enhances your Performance, but  
 will never become part of the problem...



OFTEN  
 MIMICED  
 NEVER  
 DUPLICATED

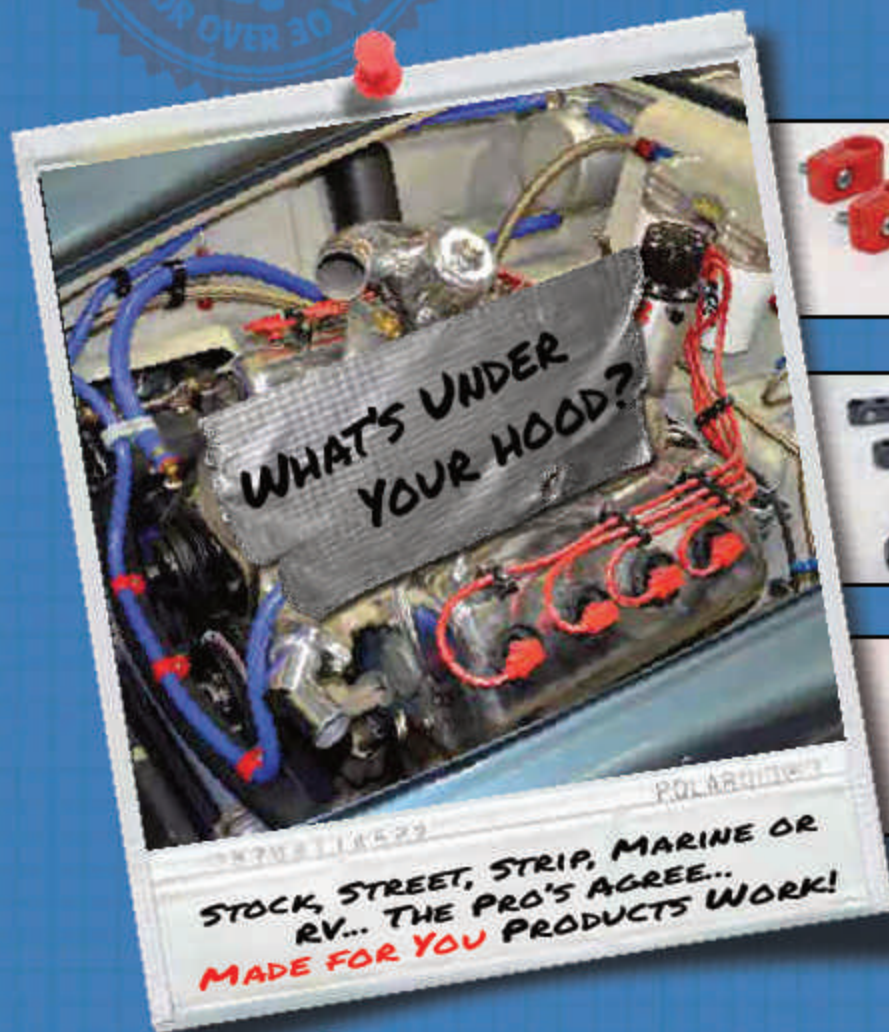

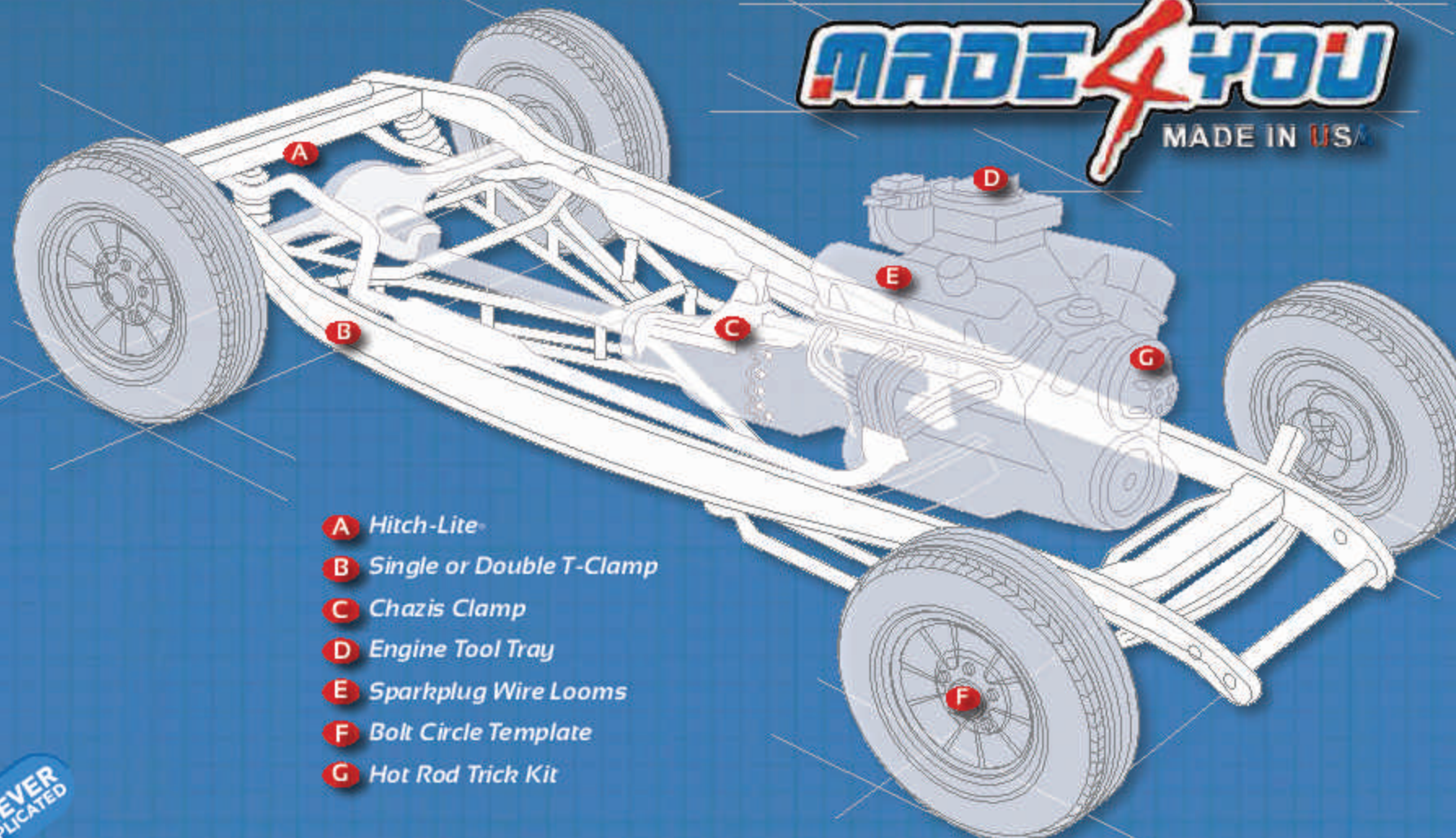
- A Hitch-Lite
- B Single or Double T-Clamp
- C Chasis Clamp
- D Engine Tool Tray
- E Sparkplug Wire Looms
- F Bolt Circle Template
- G Hot Rod Trick Kit

**Chassis-Engine-Tools-Accessories**

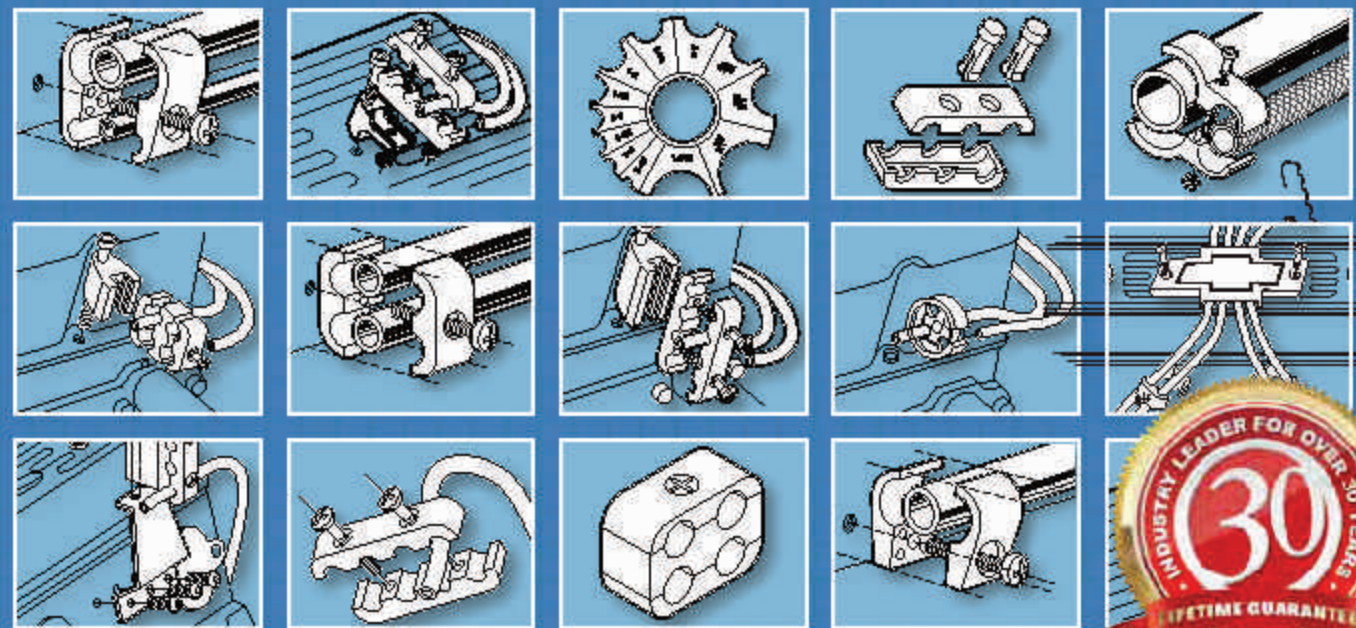

Printed in U.S.A.  
 Part # 90-00000



To Order Call: 760-868-6962

WHEN IT MATTERS® make it a rule to use Made4You



1 WE THINK IT...

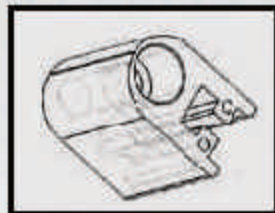
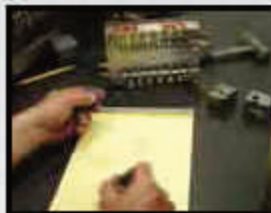

2 WE TOOL IT...

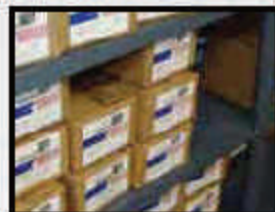
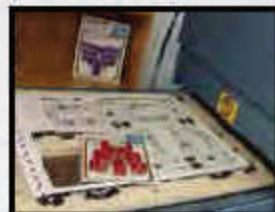

3 WE MAKE IT...

4 WE PACK IT...

5 WE SHIP IT...

WE DON'T JUST MAKE AND SELL IT... WE USE AND WIN WITH IT...

Experiments in which test pieces of GRILON (Nylon 6-6) 1mm thick were exposed to the chemical tested for a period of 10 months at ambient temperature. No, or negligible, changes in mass and dimensions were noted. GP Nucleated / A29CM Properties:

Melting Point	532°
Water Absorption	24 Hr. Immersion 79°F/23°C = 9
Flammability	UL94 / thickness Rating v-2 / 0.31 79
Heat Deflection	At 66psi Test Method ASTM D648 (1°F = 362)
Max. Usage temp	Test Method EMS 302 (in Air-Long Term)
Tensile Strength	ASTM D638-10 psi (MPa)
Electrical Comparative Tracking	ASTM D3538 600-volts
Volume Resistivity	DIN 53482 / ohm-cm = 10

Additional Technical data will be made available upon request.

Limited Warranty: Made For You Products, LLC warrants to the original consumer purchaser of any product it manufactures, that the product will be free of defects in material or workmanship. All Nylon products, such as T-Clamps and Smootheries, are unconditionally guaranteed and will be replaced if found defective. All other products have a 30 day warranty from date of purchase. Neither manufacturer nor seller shall be liable for any injury, loss, damage, or inconvenience arising directly or indirectly from the installation or use of these products or the inability to use same. It is the purchaser's responsibility to determine the suitability of the product for the intended installation, use, or application, and the purchaser assumes all risks and liabilities whatsoever in connection therewith. See our price sheet for ordering prices and procedures.

Made For You Products®, Porta-Mat®, T-Clamp®, Butn-Snap®, Spin-N-Snap®, Spoiler Saver™, Shop Rags®, SacoPat®, HITOH-Lite®, Tool-Mat®, Quik-Clich® are federally registered trademarks of Made For You Products, LLC PAT# #D369937, #324467, D462604, #D899000, #5035931, #6202515, #6710249

"I have tried other products and they don't last or they get damaged. I have had my Made for You products on for almost 25 years and they still look great" - Paul Myers



"I have been buying parts for my hot rod from Made For You products for years. I like to call. Their staff is full of great ideas and I get exceptional service" - Eddie Wixle



Family owned and operated since 1985. The industry leader of high heat resistant, light weight fastener systems for all applications

If you were wondering who we are.....

All the folks at Made For You share a commitment to provide exceptional products for the automotive, marine and aerospace and enthusiast, professional builder and racer...in other words...YOU!

We're represented by a network of retail and e-commerce distributors on both domestic and international levels.

Every step of the process, from idea to part to completed assembly, through shipping, is maintained at the highest standard, insuring consistent quality in both clerical and manufacturing procedures.

Each member of our corporate family is community involved, family oriented, and takes personal responsibility for the environment.

We are firmly rooted in individual religious commitments and proud of personal and group accomplishments.

We are over 30 years strong and look forward to another 30 years of providing you with exceptional products you demand and deserve.

We enjoy producing products that will not only work superbly for the application, make you look good and will always be part of the solution.

OFTEN IMITATED NEVER DUPLICATED

- #04 T-CLAMP
- #05 CRAZY CLAMP
- #06 SPIN-SNAP
- #06 BUTN-SNAP
- #08 SMOOTHERIE
- #10 HYPERO-TAGS
- #12 TOOL-MAID
- #12 BOO-CIRCLE
- #12 TUBE-GAUGE

When it matters®

WE DON'T JUST SPONSER THEM WE DRIVE THEM



To Order Call: 760-868-6962

WHEN IT MATTERS® make it.....Made4YouProducts.com

CONTENTS: WHO WE ARE & WHAT WE DO



## T-Clamp®, Chazis® Clamp, Smoothie, Spin-N-Snap

Precision molded from 6-6 Dupont Zytel nylon, with an UNCONDITIONAL guarantee (under normal operating conditions)

- Will not melt, fade, stain, corrode, or discolor.
- Will not crack or break from heat or cold.
- Unaffected by any automobile fluids, including brake, fuel, coolant, or solvents.
- Non-conductive.
- **Separate, organize, and support all types of hose, tubing, and wire.**
- **Economical, lightweight alternatives to expensive aluminum and metal products.**

Engineered to "pre-load", working as their own lock washer, our T-Clamps hold tubing, hoses, and wire away from the application, thereby eliminating vibration and paint chaffing. 10/32 or 1/4-20 stainless steel mounting hardware included for a professional finish.

Please add 2-digit color code to part number when ordering.



Example # 10-188-13 for Purple T-Clamp



### Single Place T-Clamps

Part #	Size	Qty	Part #	Size	Qty
10-188	3/16"	8	10-500	1/2"	6
10-250	1/4"	8	10-562	9/16" [#6AN]	6
10-313	5/16"	8	10-625	5/8"	6
10-375	3/8"	8	10-650	11/16" [#8AN]	4
10-437	7/16"	6	10-820	13/16" [#10AN]	3

### Double Place T-Clamps

Part #	Size	Qty	Part #	Size	Qty
20-252	1/4"-1/4"	6	20-377	3/8"-3/8"	6
20-258	1/4"-3/16"	6	20-432	7/16"-7/16"	4
20-288	3/16"-3/16"	6	20-502	1/2"-1/2"	4
20-323	5/16"-5/16"	6	20-522	9/16"-9/16" [#6-#6 AN]	4
20-327	5/16"-3/8"	6	20-622	5/8"-5/8"	4
20-357	3/8"-3/16"	6	20-652	11/16"-11/16" [#8-#8 AN]	4

### Heater - A/C T-Clamps

Part #	Size	Qty
20-822	13/16"-13/16" [1/2"-1/2" ID] [#10-#10 AN]	2
20-823	13/16"-15/16" [1/2"-5/8" ID]	2
20-835	15/16"-15/16" [5/8"-5/8" ID]	2
20-836	15/16"-1 1/16" [5/8"-3/4" ID]	2

\*\*All sizes OD unless otherwise indicated



### T-Clamp® Kits to Complete an Entire Car

All of our clamp kits contain 10/32 stainless steel mounting hardware for a professional finish. A durable plastic storage case is provided for easy access and organization.

#### All Plumb® T-Clamp Kit

Contains everything you need to achieve a professional chassis and under hood look. Will complete one car, clamping every 18". This complete selection of T-Clamps makes it easy to mount and route fuel, brake and transmission lines, electrical wiring, battery cables, vacuum lines and hoses.

Part # 30-899 (Available in 6 colors)

Size	Qty	Size	Qty	Size	Qty
3/16"	14	1/2"	5	5/16"-5/16"	4
1/4"	12	5/8"	6	5/16"-3/8"	4
5/16"	12	3/16"-3/16"	4	3/8"-3/8"	4
3/8"	10	3/16"-3/8"	4		

#### Brake Line Kit

If you only need to fasten a few lines, our mini-kit is just the ticket. The kit will run a full 3/16"-1/4" combination system. Will run entire brake system based on clamping every 18".

Part # 30-89011 (Available in black only)

Size	Qty	Size	Qty	Size	Qty
3/16"	10	3/16"-3/16"	5	1/4"-3/16"	5
1/4"	10	1/4"-1/4"	5		

#### Auto Wiring Kit

For rewiring or upgrading, this kit is for you. Separate and organize for easy tracking of your wiring.

Part # 30-895 (Available in 6 colors)

Size	Qty	Size	Qty	Size	Qty
3/16"	6	7/16"	8	9/16" (#6)	4
1/4"	6	1/2"	4	11/16" (#8)	4
3/8"	6				

#### Racer Clamp Kit

Designed for the requirements of professional racing and hi-performance applications, where strength and light weight are critical. Each kit contains larger sized T-Clamps (from 7/16" to 15/16") for mounting braided pressure lines, hoses, and cables. Available in black only.

Part # 30-89611 (Available in black only)

Size	Qty	Size	Qty	Size	Qty
7/16" (#4)	4	13/16" (#10)	5	13/16"-13/16"	3
9/16" (#6)	5	9/16"-9/16"	3	15/16"-15/16"	2
11/16" (#8)	5	11/16"-11/16"	3		

#### Screwless Chazis® Clamps

Easily surrounds 1-5/8" tubular chassis applications. Locking pegs will not come apart. Allows for full removal while still on line. Prevents line crimping and chaffing from pulling common tie wraps too tight. Air flows completely around line, aiding in cooling of fluids. Full range of sizes to accommodate most applications. NHRA approved. 3 Clamps per package with connectors. Available in black only.

Part #	Size	Part #	Size
41-43751	7/16" (#4)	41-65051	11/16" (#8)
41-50051	1/2"	41-82051	13/16" (#10)
41-56251	9/16" (#6)	41-83551	15/16"
41-62551	5/8"		

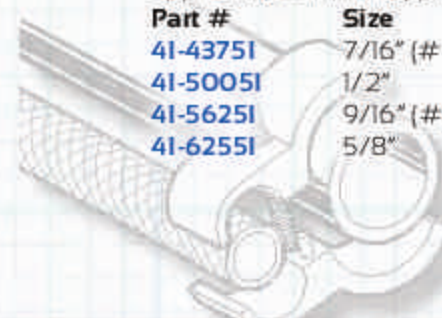

CHASSIS: FASTENERS, CLAMPS & KITS



To Order Call: 760-868-6962

WHEN IT MATTERS® make it.....Made4YouProducts.com

## Add or Remove Wire Without Tools!

Excellent for Racing Applications

This unique design allows a quick and easy method of routing any type of wires or cables anywhere. 7-8 mm wire

Just spin the inner ring to align with opening, place the cable inside, then spin to next opening. When all desired wires are in the unit, spin to 'closed' position. Now your wires are secured.

**Part # 55-190** (w/o brackets) 2 2-Place, 2 3-Place and 2 4-Place (no hardware)



3 Easy Steps



## Butn-Snap® Wire Loom Kits

No hardware!

Self-locking pegs snap into place, securing both sides of the separator together.

Kit contains two, 2-place, 3-place, and 4-place separators.

**Part # 50-056** 7-8 mm wire only



### 4-Place Box Cluster

Perfect where space is limited. Places the wires two over two. Can be used with Smoothie brackets (see P/N 50-556 Stac-Pak) or added as an extra wire support to any kit. 4 units per pack. Stainless screws included.

**Part # 50-456** 7-8 mm wire only



WANT YOUR NAME HERE?  
JUST CALL



## HITCH-Lite®

Dress up your receiver and add the EXTRA SAFETY OF A THIRD BRAKE Light! The patented HITCH-Lite slips into your receiver and snaps securely into place. Fully-self contained, the HITCH-Lite easily installs without the use of any tools. The flat molded connector plugs into your existing trailer hookup. Made of tough ABS to look great through years of use. Optically advanced lens design for maximum brightness with low current consumption. DOT approved.

\*30 day limited guarantee

**Part # 70-85431**

## Universal Separator Kits (Domestic)

Similar to the Butn-Snap Separators, but utilize stainless steel hardware to attach components together. Simple to install, works with virtually any engine. Contains two, 2-place, 3-place, and 4-place separators.

7/8 mm wire:  
**Part # 50-156**

10.5 mm wire:  
**Part # 50-110**

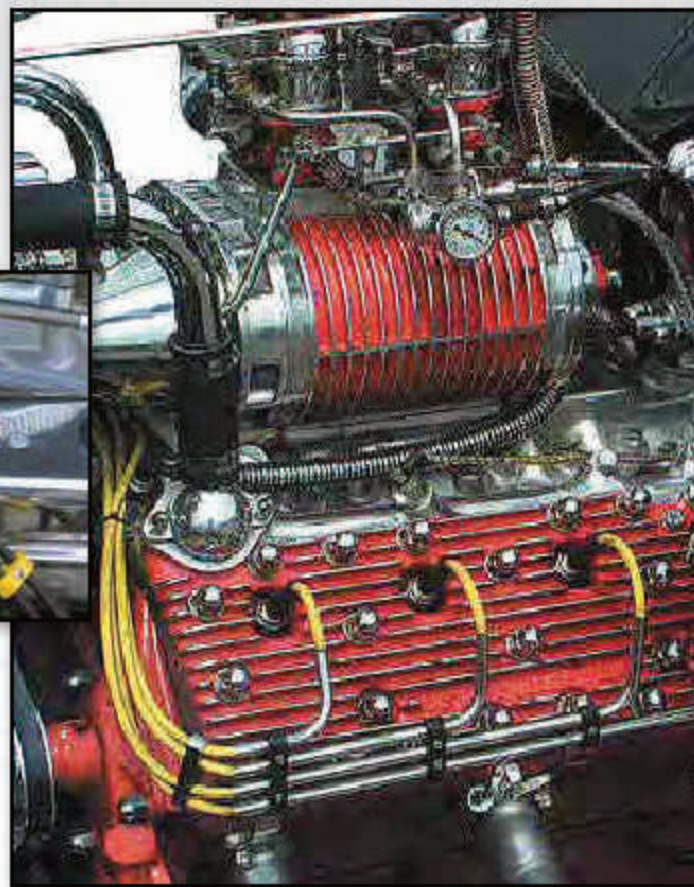
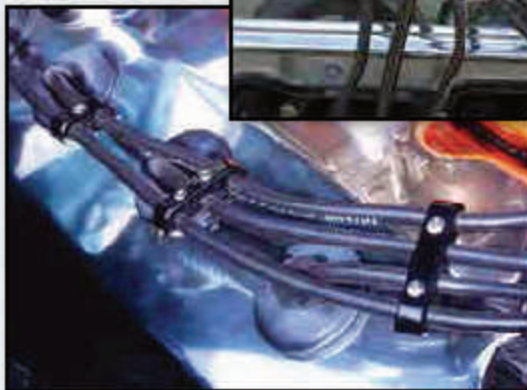

Use T-Clamps® and Smoothie® Wire Loom Kits to secure your: nitrous lines, spark plug wires, HD amp & speaker cables. Almost anything that can be securely held in place.

## Universal Sport Compact Wire Loom Kit

4 & 6 cylinder sport compacts, SUV's, and custom applications. Kit contains three, 2-place separators, one 3-place, and two, 4-place separators to loom the wires all the way to the distributor.

**Part # 50-256** 7-8 mm wire

**Part # 50-210** 10.5 mm wire

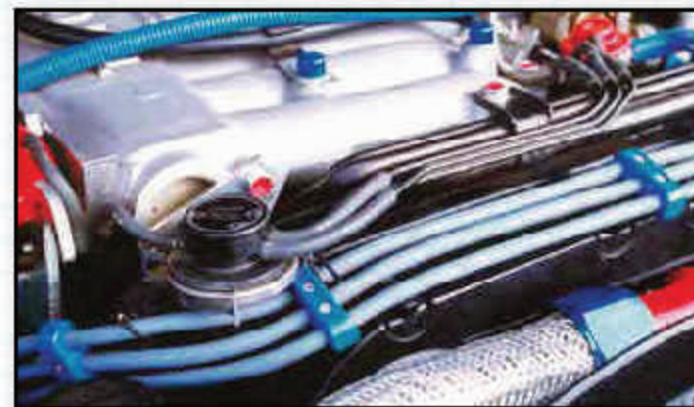

## V-6 Kits

for Sport Compacts, SUV's, & Mini-Trucks. A special kit for V-6 engines including the Buick "Grand National" cars. Similar to our Horizontal Wire Loom Kit. Each kit contains two horizontal brackets, two, 2-place and four, 3-place wire separators.

**Part # 50-656** 7-8 mm wire



To Order Call: 760-868-6962

WHEN IT MATTERS® make it.....Made4YouProducts.com



### Why buy from us? Because.....

- 1. More Choice** - Largest variety in the industry  
Kits to fit almost any application, in 7-8 mm, and 10.5 mm sizes.  
Six classic colors to coordinate with your paint and T-Clamps®
- 2. Unsurpassed Quality**  
Precision molded 6-6 Zytel Nylon will not melt, fade, distort, stain, or DISCOLOR. (under normal use.)  
Not affected by automotive brake fluid, antifreeze coolant, fuel, solvents, heat or cold.  
Stainless steel hardware included where applicable.
- 3. More affordable** - You won't have to replace due to part failure.  
We give you an **unconditional** lifetime warranty.

Separate, organize, and support your ignition wires, while protecting them from heat and vibration.

- Non-conductive. Eliminates crossfire, increasing performance.
- \*not all kits available in 10.5 mm-see individual product description



Please add 2-digit color code to part number when ordering. Example **#50-556-13** for **RED** Stac-Pak®

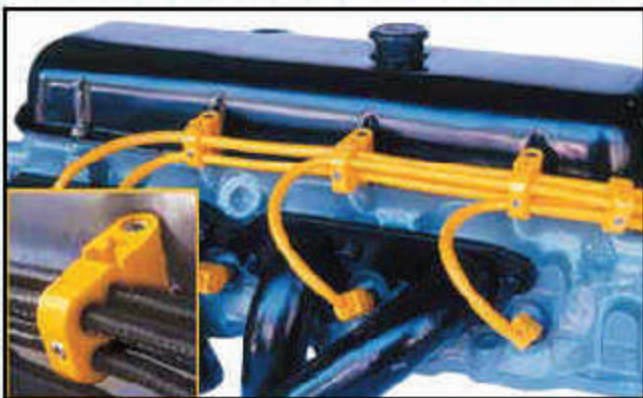

### Smoothie® Separator Kits for Most V-8's Stac-Pak® Wire Loom Kit

Designed for tight clearances and for vehicles running magnetos or HEI systems. The double stack designed separators maintain two-over-two ignition wires from the magneto or distributor all the way to the valve cover. Vertical mount brackets support wires out of high heat areas. Contains six brackets, eight 4-place and two 2-place box cluster separators. Fits most Ford, GM, and Dodge V-8's

**Part # 50-556** 7-8 mm wire

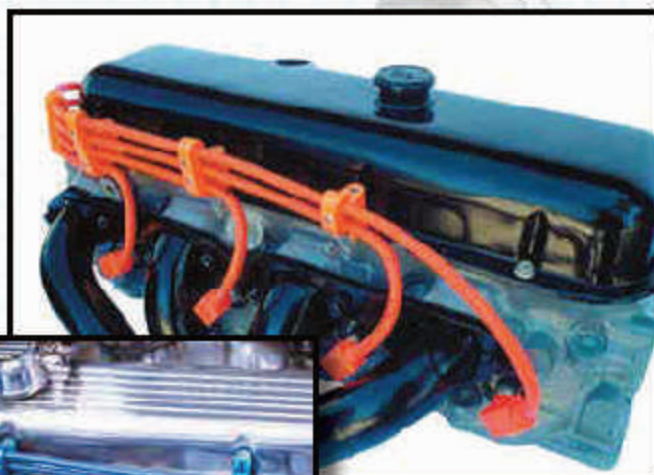

### Vertical Wire Loom Kits

Our most popular style for mounting on valve covers, allowing the separators to be positioned vertically instead of horizontally. Adjustable to allow wires to be loomed out of high heat areas, thereby making the application last longer. Contains 6 brackets, and two, 2-place, 3-place, and four 4-place separators to loom to distributor. Fits most Ford, GM, and Dodge V-8's

**Part # 50-756** 7-8 mm wire

**Part # 50-710** 10.5 mm wire

### Horizontal Wire Loom Kits

Lays the wires out parallel to the valve cover. Contains 6 brackets and two, 2-place, 3-place, and four 4-place separators to allow looming all the way to the distributor. Fits most Ford, GM, and Dodge V-8's

**Part #50-956** 7-8 mm wire

**Part #50-910** 10.5 mm wire



### Smoothie® Kits for Center Bolt Valve Covers

#### Bowtie® Wire Loom Kit

Designed for the true Chevy enthusiast! Licensed by General Motors, our kit provides a unique option for supporting and protecting spark plug wires on center bolt applications. Each kit contains two of the Bowtie shaped separators, four 2-place separators, and two 4-place separators to loom the wires back to the distributor. Mounts easily to existing valve cover holes with extra long (4") stainless steel bolts provided in the kit. Looks great on stock or aftermarket valve covers.

**Part # 60-730** 7-8 mm wire

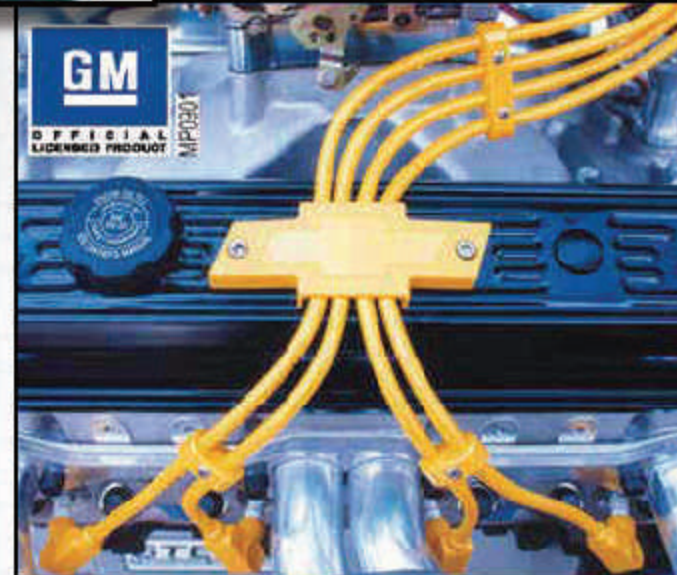

#### Top Mount Wire Loom Kit

Similar to our #50-956 Horizontal Wire Loom Kit, but with longer bolts. Gives a neat, professional, custom look while keeping wires out of the high heat areas. Complements your chrome or billet accessories.

**Part # 50-356** 7-8 mm wire

**Part # 50-310** 10.5 mm wire



#### Side Mount Aluminum Bracket Kit

If you're running engraved valve covers and don't want to hide them, or just want to be able to remove the covers without touching the spark plug wires, this application is perfect. Use existing hole(s) in the side of the heads, to mount aluminum brackets. Four brackets per package. Includes hardware.

**Part # 50-82494**

(Use with P/N 50-756 sold separately.)

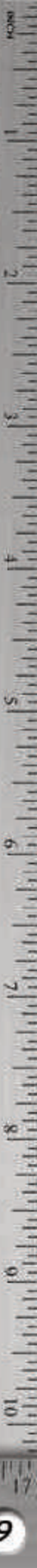



14 colors to choose from  
Part# 70-980-XX

Black-11	Purple-20
Blue-12	Clear-21
Red-13	Beige-22
Yellow-15	Carbon-23
Pink-16	Green-26
Orange-17	Patriot-27
Shimmer-19	Chrome-28

Gives hoses, tubing, and wiring a custom, braided look. Provides additional protection from abrasion, cuts, and cold. Expandable nylon will cover heater and air conditioning hoses, radiator hoses, vacuum lines, or bundle electrical wires. Colors coordinate with our T-Clamps and loom kits.

Part #70-980

Kit contains:

Qty	Sleeving Size	Fits Sleeving Size Range	Qty	Sleeving Size	Fits Sleeving Size Range
10'	1/4"	1/8" - 7/16"	8'	3/8"	3/16" - 5/8"
6'	1/2"	1/4" - 3/4"	10	3/4"	1/2" - 1 1/2"
4'	1 1/4"	3/4" - 1 3/4"	3	1 3/4"	1 1/4" - 2 3/4"

Individual Braided Metal, Retro Braid and Heat Shield Tubing (Available in different sizes and lengths)

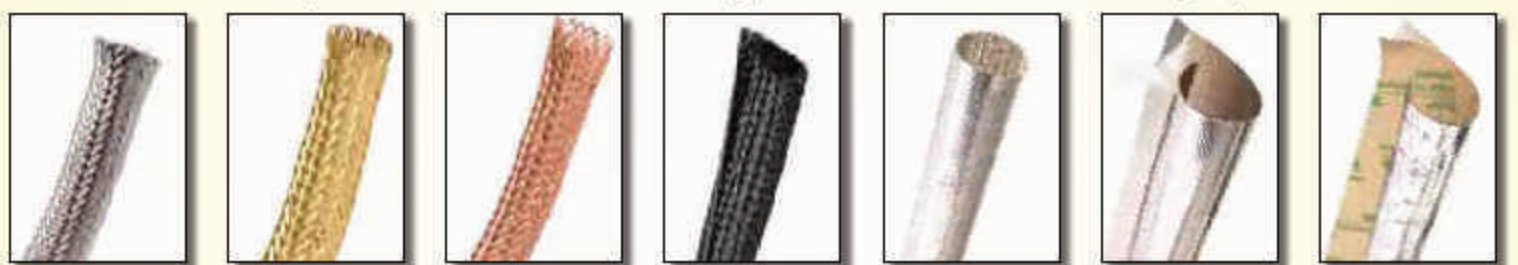

Braided Stainless #70-99531 Braided Brass #70-99532 Braided Copper #70-99533 Retro Braid #70-99511 Heat Shield Tube #70-94610 Heat Shield Wrap #70-94620 Heat Shield Flap #70-94630

Not only do we cover, shield and protect; but we can customize to your needs with these specialty items.



Braided Stainless Part #70-99531



HotRod TrickKit-Red Part #70-980-13



HotRod TrickKit-Chrome Part #70-980-28

Shrink Tubing Kits

At Made4You, we anticipate customers' needs to determine which product is best for your project. Nothing can be more frustrating than having the wrong size shrink tubing in the middle of a job. To help solve this, we created a new series of multi-size shrink tubing kits. Our kits have 6 sizes to work with and give you a perfect selection. Available in black or an assorted colors kit.

Size	Quantity 6" Length
1/8"	30 Pieces
1/4"	20 Pieces
3/8"	20 Pieces
1/2"	20 Pieces
3/4"	10 Pieces
1"	10 Pieces



Part #70-9713I



Part #70-9711I



Hot Knife Part #80-35200



Handheld Hot Knife

Perfect for individual projects or small volume production. The large knife blade heats quickly and easily cuts and seals most grades of braided sleeving. The handle can also be used as a soldering gun with the appropriate tips. 110 volt operation.



Hot Knife Replacement Blade Part #80-35210



Hot Knife Accessory Kit Part #80-35220



#70-940-11 #70-940-12 #70-940-13 #70-940-14



Performance Insulating Sleeves Part #70-940-14



To Order Call: 760-868-6962

WHEN IT MATTERS® make it.....Made4YouProducts.com

# TUBE GAUGE

## Hose & Tube Gauge

No more second-guessing which size clamp to purchase! Easily and accurately measure the outside diameter of all your tubing, hose, and wire so you can pick the right T-Clamp for a perfect fit every time. Molded from tough ABS, the Hose and Tube Gauge should be in every toolbox.

Part # 80-11492

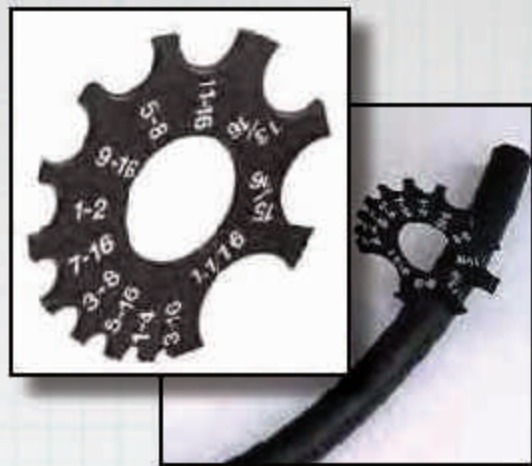

## Tool Maid® Engine Tool Tray

Have you ever wondered which wire went where? Which cylinder was running lean or rich? Dropped a nut down the carburetor?

Forgot where you laid that tool you just had?

If you answer "yes" to any of these questions, you need the patented Tool Maid® engine tool tray. This handy, lightweight 12" x 14" tray mounts directly on 4-barrel carburetors using the stock stud and nut. Large, angled compartments keep tools and small parts within easy reach. The side panels conveniently hold plugs and wires out of the way and keeps them in order. Tray is constructed of gas and oil resistant polypropylene.

Part # 80-13456 (Available in grey only)



# BOULTCIRCLE

## Wheel Bolt Circle Template

Quickly check the lug bolt pattern for almost any wheel. A must when fitting custom wheels. Saves time and money. Made of tough ABS to assure accuracy for years. Easy to read numbers.

P/N 80-21392

Red 5 lug SAE: 4-1/2", 4-3/4", 5", and 5-1/2"

P/N 80-21492

Blue 4 lug Metric: 98mm, 100mm, 4-1/4", 4-1/2"

P/N 80-21592

Yellow 5 lug Metric: 100mm, 112mm, 115mm, 120mm

P/N 80-21692

Gray 6 lug SAE for trucks: 127mm, 5-1/2", 6-1/2"

P/N 80-21200

Complete kit has one each of all the above.



←  
WANT YOUR  
NAME HERE?  
JUST CALL

Single  
T-Clamp  
3/16"  
P/N 10-188  
1/4"  
P/N 10-250



Single  
T-Clamp  
7/16"  
P/N 10-437  
5/16"  
P/N 10-313  
3/8"  
P/N 10-375



Single  
T-Clamp  
1/16"  
P/N 10-650  
1/2"  
P/N 10-500  
9/16"  
P/N 10-562  
5/8"  
P/N 10-625



Single  
T-Clamp  
13/16"  
P/N 10-820



Double  
T-Clamp  
1/4"-1/4"  
P/N 20-252  
3/16"-1/4"  
P/N 20-258  
3/16"-3/16"  
P/N 20-288



Double  
T-Clamp  
5/16"-5/16"  
P/N 20-323  
5/16"-3/8"  
P/N 20-327  
3/8"-3/8"  
P/N 20-377  
3/16"-3/8"  
P/N 20-357  
7/16"-7/16"  
P/N 20-432  
1/2"-1/2"  
P/N 20-502



Double  
T-Clamp  
9/16"-9/16"  
P/N 20-522  
5/8"-5/8"  
P/N 20-622  
1/16"-1/16"  
P/N 20-652



Heater-A/C  
13/16"-13/16"  
P/N 20-822  
13/16"-15/16"  
P/N 20-823  
15/16"-15/16"  
P/N 20-835  
15/16"-115/16"  
P/N 20-835



Chassis Clamp  
7/16" (#4)  
41-43751  
1/16" (#8)  
41-65051  
1/2"  
41-50051  
13/16" (#10)  
41-82051  
9/16" (#6)  
41-56251  
15/16"  
41-83551  
5/8"  
41-62551



All Plumb Kit  
P/N 30-899



Racer Clamp Kit  
P/N 30-896



Auto Wiring Kit  
P/N 30-895



Brake Line Kit  
P/N 30-890



To Order Call: 760-868-6962

WHEN IT MATTERS® make it.....Made4YouProducts.com

Butn-Snap® Kit  
7-8mm  
P/N 50-056



Standard  
Unvrsl Kit  
7-8mm  
P/N 50-156  
10.5mm  
P/N 50-110



Import  
Universal Kit  
7-8mm  
P/N 50-256  
10.5mm  
P/N 50-210



Centerbolt  
Horizontal  
7-8mm  
P/N 50-356  
10.5mm  
P/N 50-310



4 Place  
Box Cluster  
7-8mm  
P/N 50-456



Stac-Pak® Kit  
7-8mm  
P/N 50-556



V-6 Kit  
7-8mm  
P/N 50-656  
P/N 50-610



Vertical Kit  
7-8mm  
P/N 50-756  
10.5mm  
P/N 50-710



Aluminum  
Bracket Kit  
P/N 50-82494  
(Use with P/N  
50-756)



Horizontal Kit  
7-8mm  
P/N 50-956  
10.5mm  
P/N 50-910



Spin-n-Snap®  
Universal Kit  
7-8mm  
P/N 55-190



Centerbolt  
Bowtie®  
7-8mm  
P/N 60-730



Bolt Circle  
Template & Kit  
P/N 80-21200  
P/N 80-21392  
P/N 80-21492  
P/N 80-21592  
P/N 80-21692



Tube &  
Hose Gauge  
P/N 80-11492



Shrink Tubing Kit  
P/N 70-97131



Shrink Tubing Kit  
P/N 70-97111



Hot Knife  
Accessory Kit  
P/N 80-35220



Hot Knife  
Replacement Blade  
Part #80-35210



Hot Knife  
P/N 80-35200



Braided Stainless  
#70-99531

Braided Brass  
#70-99532

Braided Copper  
#70-99533



Retro Braid  
#70-99511



Heat Shield Tube  
#70-94610

Heat Shield Wrap  
#70-94620

Heat Shield Flap  
#70-94630



Performance  
Insulating Sleeves  
P/N 70-940-XX



Hitch-Lite®  
P/N 70-85431

Tool Maid®  
EngineTool Tray  
P/N 80-13456



Hot Rod Tric Kit  
P/N 70-980

